



ATTENTION

OBSERVE PRECAUTIONS
FOR HANDLING
ELECTROSTATIC
DISCHARGE
SENSITIVE
DEVICES

Part No./型号: 515XB7C

Ø Features/特征:

- I Single color/单色
- I High bright output/高亮度输出
- I Low power consumption/低功耗
- I High reliability and long life/
可靠性高、寿命长

Ø Descriptions/描述:

- I Dice material/芯片材质: GaN
- I Emitting Color/发光颜色:
Super Bright Blue/ 高亮度蓝色
- I Device Outline/产品外形:
φ5mm Round Type/ 5mm 圆形
- I Lens Type 胶体颜色:
Water Clear/ 无色透明

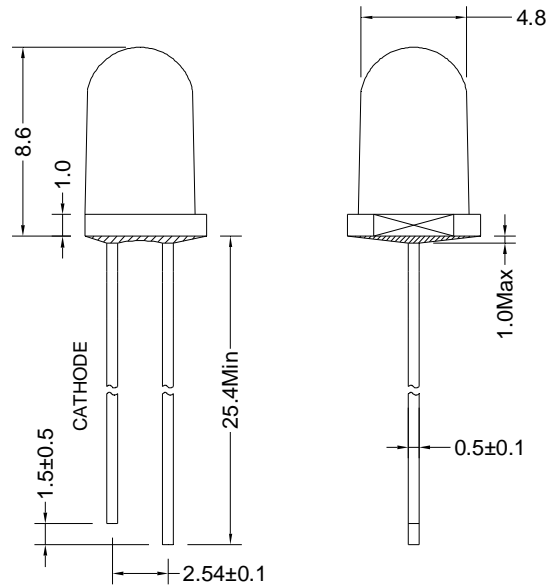
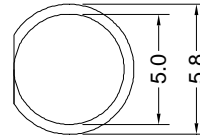

1. All dimensions are millimeters/单位: mm.
2. Tolerance is +/-0.20mm unless otherwise noted/
没有标注的公差均为±0.20mm.

Ø Directivity/指向特性:

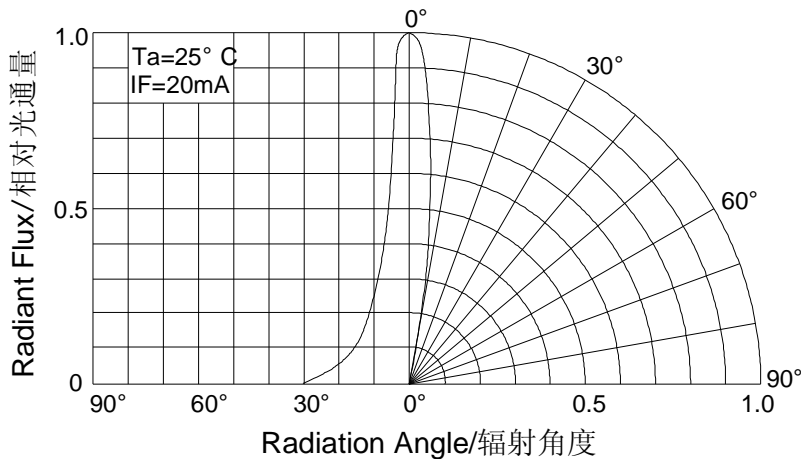

**Ø Absolute maximum ratings/极限参数 (Ta = 25°C)**

Parameter 参数	Symbol 符号	Test Condition 测试条件	Values 数值		Unit 单位
			Min.	Max.	
Reverse Voltage 反向电压	V _R	I _R = 30 μ A	5	--	V
Forward Current 正向工作电流	I _F	----	----	25	mA
Power Dissipation 损耗功率	P _d	----	----	90	mW
Pulse Current 正向峰值电流	I _{peak}	Duty=0.1mS, 1kHz	----	100	mA
Operating Temperature 工作温度范围	T _{opr}	----	-40	+85	°C
Storage Temperature 储存温度范围	T _{str}	----	-40	+100	°C

Ø Electrical and optical characteristics/光电参数 (Ta = 25°C)

Parameter 参数	Symbol 符号	Test Condition 测试条件	Values 数值			Unit 单位
			Min.	Typ.	Max.	
Forward Voltage 正向电压	V _F	I _F =20mA	----	3.2	3.6	V
Reverse Current 反向电流	I _R	V _R =5V	----	----	30	μ A
Dominate Wavelength 主波长	λ _d	I _F =20mA	----	470	----	nm
Peak Wavelength 峰值波长	λ _p	I _F =20mA	----	468	----	nm
Spectral Line half-width 半波长宽度	Δ λ	I _F =20mA	----	30	----	nm
Luminous Intensity 发光强度	I _v	I _F =20mA	4000	5600	----	mcd
Viewing Angle 指向角度	2 θ 1/2	I _F =20mA	----	15	----	deg.



Ø Typical electrical/optical characteristic curves/光电特性曲线:

Fig.1 正向电流 Vs. 正向电压

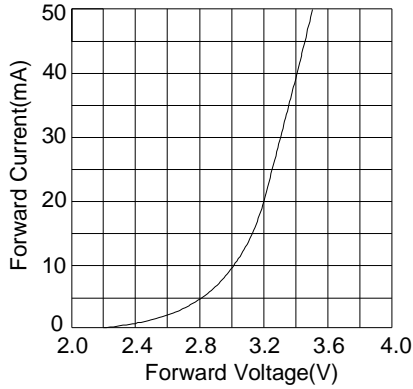

Fig.2 相对亮度 Vs. 正向电流

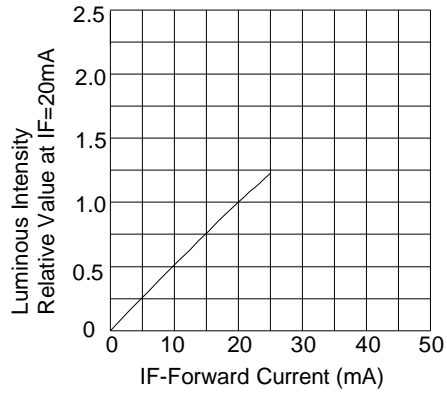

Fig.3 正向电流 Vs. 环境温度

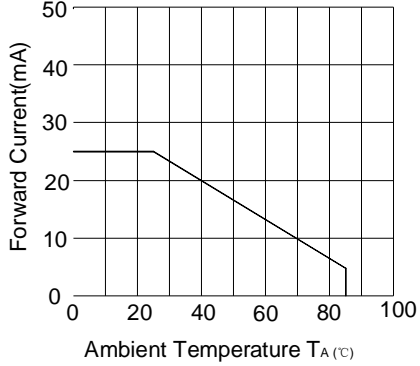

Fig.4 相对亮度 Vs. 环境温度

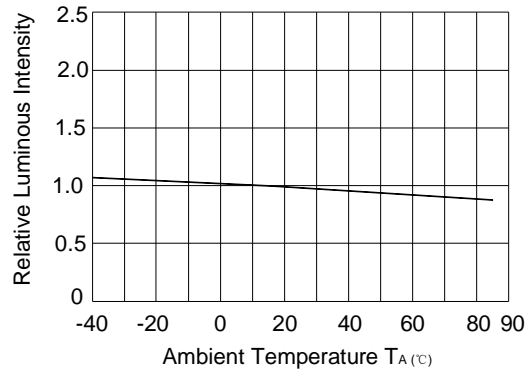

Fig.5 相对亮度 Vs. 波长

